



LCD Monitor User Manual

24G2/24G2U/27G2/27G2U

LED backlight



Safety.....	3
National Conventions.....	3
Power	4
Installation.....	5
Cleaning.....	6
Other.....	7
Setup	8
Contents in Box	8
Setup Base	9
Adjusting the monitor	10
Connecting the Monitor.....	11
Freesync function	12
Adjusting.....	13
Hotkeys.....	13
OSD Setting.....	14
Luminance	15
Image Setup	16
Color Setup.....	17
Picture Boost	18
OSD Setup	19
Game Setting.....	20
Extra	21
Exit.....	22
LED Indicator.....	22
Driver	23
G-Menu.....	23
e-Saver	24
Screen+	25
Troubleshoot.....	26
Specification.....	28
General Specification.....	28
Preset Display Modes.....	30
Pin Assignments	31
Plug and Play.....	33

Safety

National Conventions

The following subsections describe notational conventions used in this document.

Notes, Cautions, and Warnings

Throughout this guide, blocks of text may be accompanied by an icon and printed in bold type or in italic type. These blocks are notes, cautions, and warnings, and they are used as follows:



NOTE: A NOTE indicates important information that helps you make better use of your computer system.





CAUTION: A CAUTION indicates either potential damage to hardware or loss of data and tells you how to avoid the problem.





WARNING: A WARNING indicates the potential for bodily harm and tells you how to avoid the problem. Some warnings may appear in alternate formats and may be unaccompanied by an icon. In such cases, the specific presentation of the warning is mandated by regulatory authority.

Power

 The monitor should be operated only from the type of power source indicated on the label. If you are not sure of the type of power supplied to your home, consult your dealer or local power company.

 The monitor is equipped with a three-pronged grounded plug, a plug with a third (grounding) pin. This plug will fit only into a grounded power outlet as a safety feature. If your outlet does not accommodate the three-wire plug, have an electrician install the correct outlet, or use an adapter to ground the appliance safely. Do not defeat the safety purpose of the grounded plug.

 Unplug the unit during a lightning storm or when it will not be used for long periods of time. This will protect the monitor from damage due to power surges.

 Do not overload power strips and extension cords. Overloading can result in fire or electric shock.

 To ensure satisfactory operation, use the monitor only with UL listed computers which have appropriate configured receptacles marked between 100 - 240V ~, Min. 5A

 The wall socket shall be installed near the equipment and shall be easily accessible.

Installation

! Do not place the monitor on an unstable cart, stand, tripod, bracket, or table. If the monitor falls, it can injure a person and cause serious damage to this product. Use only a cart, stand, tripod, bracket, or table recommended by the manufacturer or sold with this product. Follow the manufacturer's instructions when installing the product and use mounting accessories recommended by the manufacturer. A product and cart combination should be moved with care.

! Never push any object into the slot on the monitor cabinet. It could damage circuit parts causing a fire or electric shock. Never spill liquids on the monitor.

! Do not place the front of the product on the floor.

! Leave some space around the monitor as shown below. Otherwise, air-circulation may be inadequate hence overheating may cause a fire or damage to the monitor.

See below the recommended ventilation areas around the monitor when the monitor is installed on the wall or with the stand:

Installd on the wall

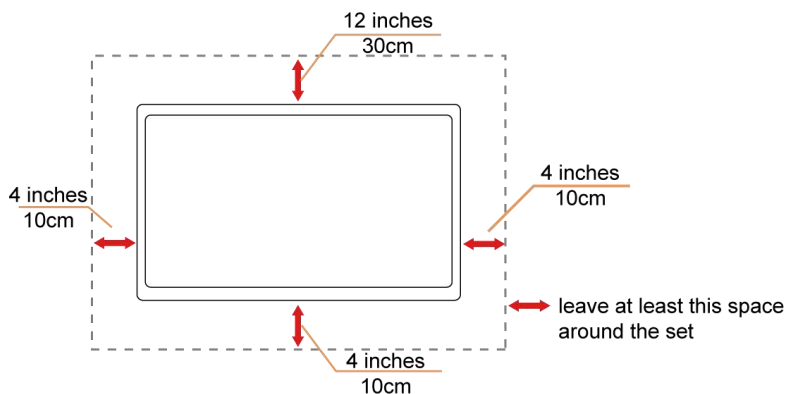

Installd with stand

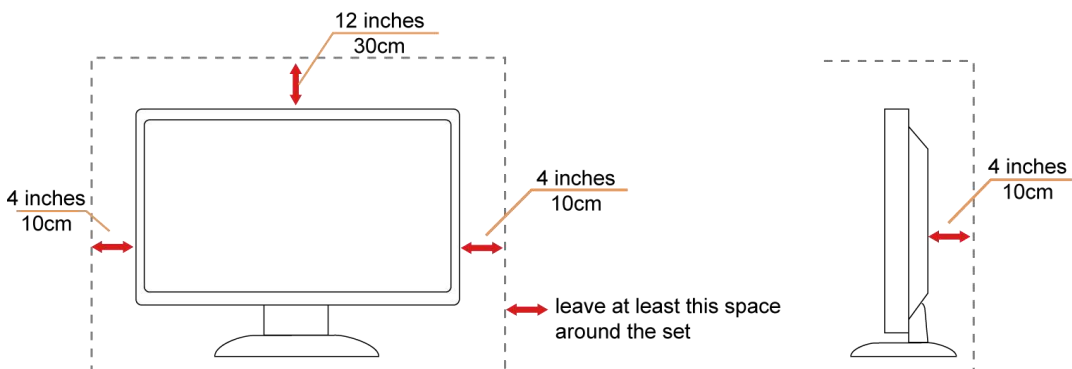

Cleaning

! Clean the cabinet regularly with cloth. You can use soft-detergent to wipe out the stain, instead of strong-detergent which will cauterize the product cabinet.

! When cleaning, make sure no detergent is leaked into the product. The cleaning cloth should not be too rough as it will scratch the screen surface.

! Please disconnect the power cord before cleaning the product.



Other

 If the product is emitting a strange smell, sound or smoke, disconnect the power plug IMMEDIATELY and contact a Service Center.

 Make sure that the ventilating openings are not blocked by a table or curtain.

 Do not engage the LCD monitor in severe vibration or high impact conditions during operation.

 Do not knock or drop the monitor during operation or transportation.

 For display with glossy bezel the user should consider the placement of the display as the bezel may cause disturbing reflections from surrounding light and bright surfaces.

Setup

Contents in Box

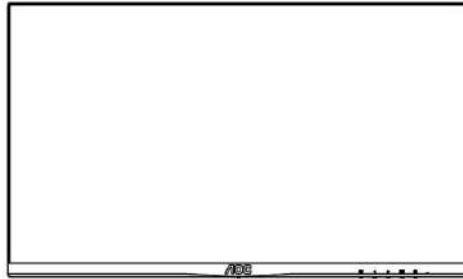

Monitor

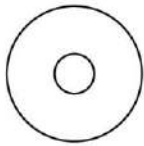

CD Manual



Warranty card

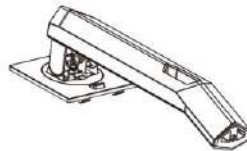

Stand

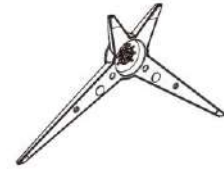

Base



Power Cable



HDMI Cable



DP Cable



VGA Cable



USB Cable



Audio Cable

* Not all signal cables (HDMI / DP / VGA / USB / Audio cables), CD manual will be provided for all countries and regions. Please check with the local dealer or AOC branch office for confirmation.

Setup Base

Please setup or remove the base following the steps as below.

Please place the monitor on a soft and flat surface to prevent the scratch.

Setup:

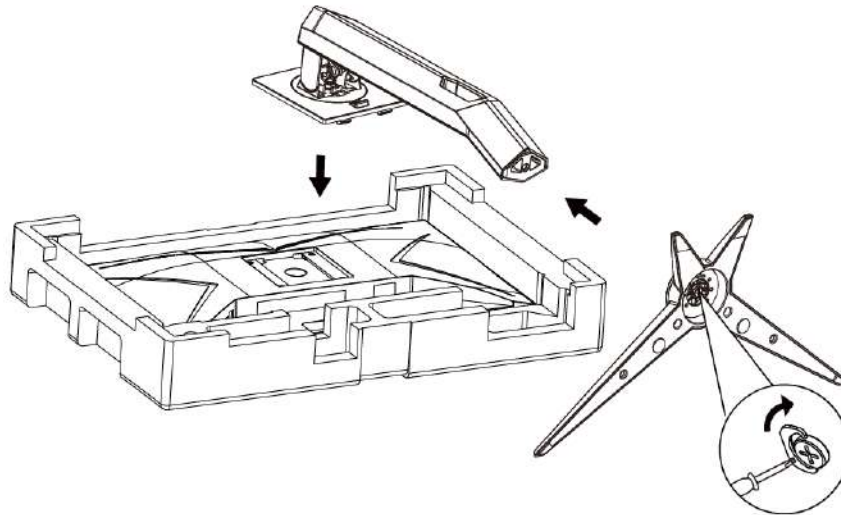

Remove:

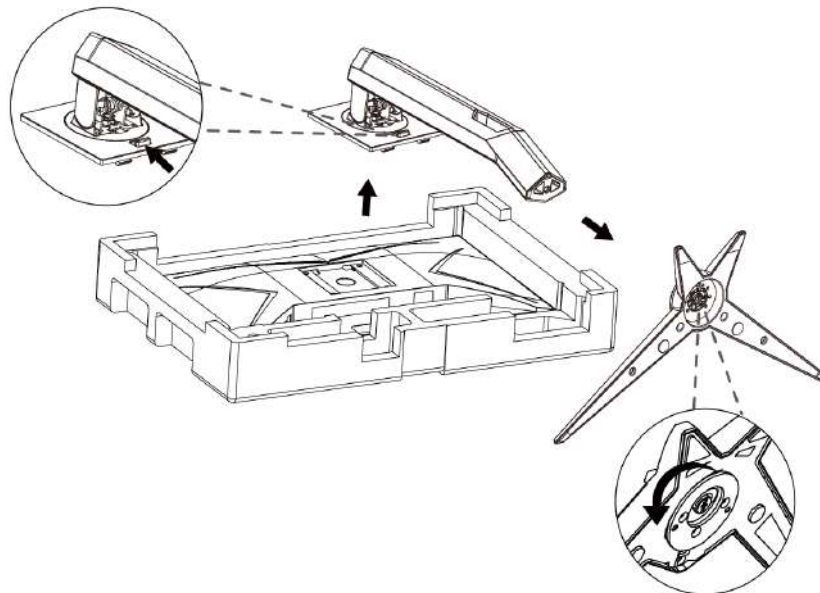

Adjusting the monitor

For optimal viewing, it is recommended to look at the full face of the monitor, and then adjust the monitor's angle to your own preference.

Hold the stand so you will not topple the monitor when you change the monitor's angle.

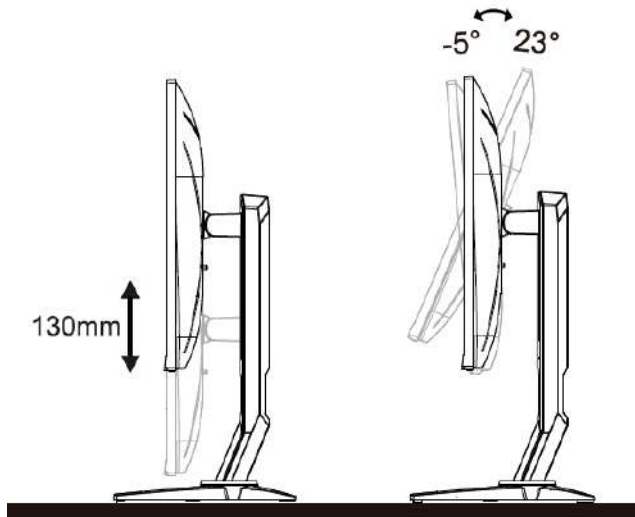

NOTE:

Do not touch the LCD screen when you change the angle. It may cause damage or break the LCD screen.

Connecting the Monitor

Cable Connections In Back of Monitor and Computer:

24G2/27G2

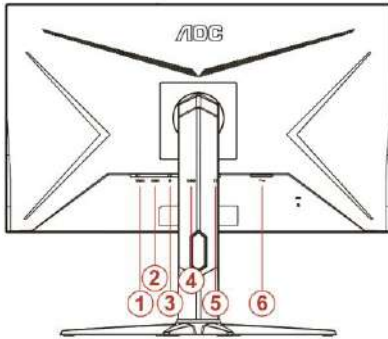

24G2U

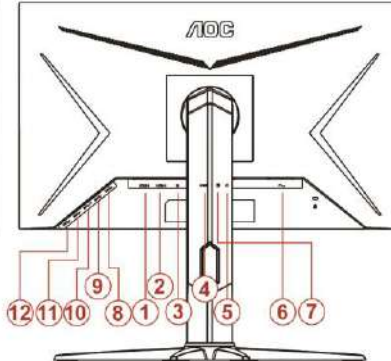

27G2U

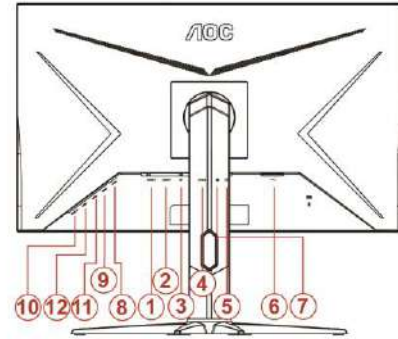

- 1 HDMI 2
- 2 HDMI 1
- 3 DP
- 4 Analog (D-Sub 15-Pin VGA cable)
- 5 Earphone out
- 6 Power
- 7 Line in
- 8 USB-PC upstream
- 9 USB 3.2 Gen 1
- 10 USB3.2Gen1+Quick Charging
- 11 USB 3.2 Gen 1
- 12 USB 3.2 Gen 1

To protect equipment, always turn off the PC and LCD monitor before connecting.

1. Connect the power cable to the AC port on the back of the monitor.
2. Connect one end of the 15-pin D-Sub cable to the back of the monitor and connect the other end to the computer's D-Sub port.
3. (Optional – Requires a video card with HDMI port) - Connect one end of the HDMI cable to the back of the monitor and connect the other end to the computer's HDMI port.
4. (Optional – Requires a video card with DP port) - Connect one end of the DP cable to the back of the monitor and connect the other end to the computer's DP port.
5. Turn on your monitor and computer.

If your monitor displays an image, installation is complete. If it does not display an image, please refer Troubleshooting.

Freesync function

1. Freesync function is working with DP/HDMI1/HDMI2
2. Compatible Graphics Card: Recommend list is as the below, also could be checked by visiting www.AMD.com

- AMD Radeon™ RX 480

- AMD Radeon™ RX 470

- AMD Radeon™ RX 460

Radeon Pro Duo

- AMD Radeon R9 300 Series

- AMD Radeon R9 Fury X

- AMD Radeon R9 360

- AMD Radeon R7 360

- AMD Radeon R9 295X2

- AMD Radeon R9 290X

- AMD Radeon R9 290

- AMD Radeon R9 285

- AMD Radeon R7 260X

- AMD Radeon R7 260

Adjusting

Hotkeys

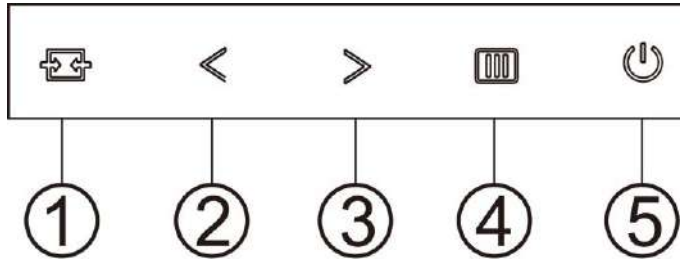

1	Source/Auto/Exit
2	Game Mode/<
3	Dial Point/>
4	Menu/Enter
5	Power

Source/Auto/Exit

When the OSD is closed, press “” button will be Source hot key function.

When the OSD is closed, press “” button continuously about 2 seconds to do auto configure (Only for the models with D-Sub).

Game Mode/<

When there is no OSD, press “<” key to open game mode function, then press “<” or “>” key to select game mode (FPS, RTS, Racing, Gamer 1, Gamer 2 or Gamer 3) basing on the different game types.

Dial Point

When there is no OSD, press Dial Point button to active Dial Point menu, and then press “<” or “>” to set Dial Point on or off.

Menu/Enter

When there is no OSD, Press to display the OSD or confirm the selection.







Power

Turn on/off the monitor.

OSD Setting

Basic and simple instruction on the control keys.



1. Press the  **MENU-button** to activate the OSD window.
2. Press **<** or **>** to navigate through the functions. Once the desired function is highlighted, press the  to activate it. If there is a sub-menu, press **<** or **>** to navigate through the sub-menu functions.
3. Press **<** or **>** to change the settings of the selected function. Press  to exit. If you want to adjust any other function, repeat steps 2-3.
4. OSD Lock Function: To lock the OSD, press and hold the  **MENU-button** while the monitor is off and then press  **power button** to turn the monitor on. To un-lock the OSD - press and hold the  **MENU-button** while the monitor is off and then press  **power button** to turn the monitor on.

Notes:

1. If the product has only one signal input, the item of "Input Select" is disabled.
2. If the product screen size is 4:3 or input signal resolution is native resolution, the item of "Image Ratio" is disabled.
3. One of Clear vision, DCR, Color Boost and Picture Boost functions is activated; the other three functions are turned off accordingly.

Luminance



1 Press **MENU** (Menu) to display menu.

2 Press **<** or **>** to select (Luminance), and press to enter.

3 Press **<** or **>** to select submenu.











4 Press **<** or **>** to adjust.

5 Press to exit.

	Contrast	0-100		Contrast from Digital-register.
	Brightness	0-100		Backlight Adjustment
	Eco mode	Standard	<input checked="" type="checkbox"/>	Standard Mode
		Text		Text Mode
		Internet		Internet Mode
		Game		Game Mode
		Movie		Movie Mode
		Sports		Sports Mode
		Reading		Reading Mode
	Gamma	Gamma1	Adjust to Gamma 1	
		Gamma2	Adjust to Gamma 2	
		Gamma3	Adjust to Gamma 3	
	DCR	Off		Disable dynamic contrast ratio
		On		Enable dynamic contrast ratio
	HDR Effect	OFF	Adjust HDR Effect	
HDR Picture				
HDR Movie				
HDR Game				

Image Setup







- 1 Press  **MENU** (Menu) to display menu.
- 2 Press  or  to select  (Luminance), and press  to enter.
- 3 Press  or  to select submenu.
- 4 Press  or  to adjust.
- 5 Press  to exit.

	Clock	0-100	Adjust picture Clock to reduce Vertical-Line noise.
	Phase	0-100	Adjust Picture Phase to reduce Horizontal-Line noise.
	Sharpness	0-100	Adjust picture sharpness.
	H. Position	0-100	Adjust the horizontal position of the picture.
	V. Position	0-100	Adjust the vertical position of the picture.

Color Setup





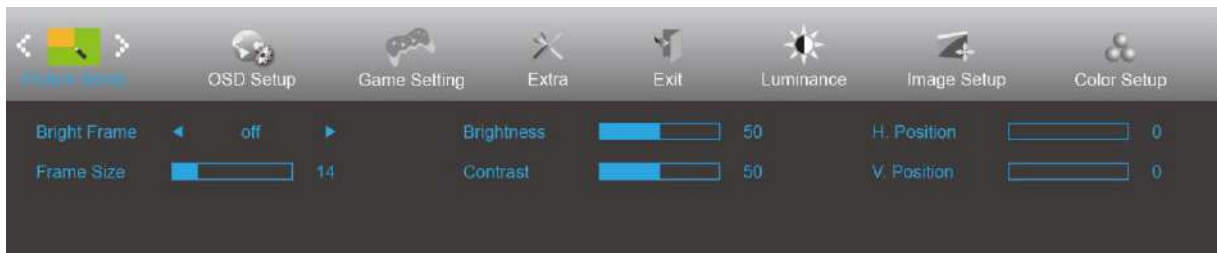

- 1 Press  **MENU** (Menu) to display menu.
- 2 Press < or > to select  (Luminance), and press  to enter.
- 3 Press < or > to select submenu.
- 4 Press < or > to adjust.
- 5 Press  to exit.

	Color Temp.	Warm		Recall Warm Color Temperature from EEPROM.
		Normal		Recall Normal Color Temperature from EEPROM.
		Cool		Recall Cool Color Temperature from EEPROM.
		sRGB		Recall SRGB Color Temperature from EEPROM.
		User		Recall User Color Temperature from EEPROM
	DCB Mode	Full Enhance	ON/OFF	Disable or Enable Full Enhance Mode.
		Nature Skin	ON/OFF	Disable or Enable Nature Skin Mode.
		Green Field	ON/OFF	Disable or Enable Green Field Mode.
		Sky-blue	ON/OFF	Disable or Enable Sky-blue Mode.
		AutoDetect	ON/OFF	Disable or Enable AutoDetect Mode.
	DCB Demo		ON/OFF	Disable or Enable Demo.
	Red		0-100	Red gain from Digital-register.
	Green		0-100	Green gain from Digital-register.
Blue		0-100	Blue gain from Digital-register.	

Picture Boost



- 1 Press  **MENU** (Menu) to display menu.
- 2 Press **<** or **>** to select  (Luminance), and press  to enter.
- 3 Press **<** or **>** to select submenu.
- 4 Press **<** or **>** to adjust.
- 5 Press  to exit.





	Bright Frame	ON/OFF	Enable/Disable Bright Frame
	Frame Size	14-100	Adjust the Size of the Frame
	Brightness	0-100	Brightness Adjustment for Enhance Area
	Contrast	0-100	Contrast Adjustment for Enhance Area
	H. position	0-100	Adjust the horizontal position of the Frame
	V. position	0-100	Adjust the vertical position of the Frame

Note:

Adjust the brightness, contrast, and position of the Bright Frame for better viewing experience.

OSD Setup



- 1 Press  **MENU** (Menu) to display menu.
- 2 Press < or > to select  (Luminance), and press  to enter.
- 3 Press < or > to select submenu.
- 4 Press < or > to adjust.
- 5 Press  to exit.

	Language		Select the OSD language.
	Timeout	5-120	Adjust the OSD timeout.
	DP Capability	1.1/1.2	please be noted that only DP1.2 support free sync function
	H. Position	0-100	Adjust the horizontal position of the OSD.
	V. Position	0-100	Adjust the vertical position of the OSD.
	Volume	0-100	Volume Adjustment.
	Transparence	0-100	Adjust the OSD.
	Break Reminder	ON/OFF	Break reminder if the user continuously work for more than 1hrs.

Notes:

If the DP video content supports DP1.2, please select DP1.2 for DP Capability; otherwise, please select DP1.1

Game Setting



1. Press **MENU-button** to display menu.
2. Press < or > to select  (Game setting), and press **MENU-button** to enter.
3. Press < or > to select submenu, and press **MENU-button** to enter.
4. Press < or > to adjust.
5. Press **AUTO-button** to exit.

	Game Mode	FPS	For playing FPS (first Person Shooters) games. Improves dark theme black level details.
		RTS	For playing RTS (Real Time Strategy). Improves the image quality.
		Racing	For playing Racing games, Provides fastest response time and high color saturation.
		Gamer 1	User's preference settings saved as Gamer 1.
		Gamer 2	User's preference settings saved as Gamer 2.
		Gamer 3	User's preference settings saved as Gamer 3.
		off	No optimization by Smart image game
	Shadow Control	0-100	Shadow Control Default is 50, then end-user can adjust from 50 to 100 or 0 to increase contrast for clear picture. 1. If picture is too dark to be saw the detail clearly, adjusting from 50 to 100 for clear picture.. 2. If picture is too white to be saw the detail clearly, adjusting from 50 to 0 for clear picture
	Low input Lag	ON/OFF	Turn off frame buffer to decrease input lag
	Game Color	0-20	Game Color will provide 0-20 level for adjusting saturation to get better picture.
	LowBlue Mode	Reading / Office / Internet / Multimedia / Off	Decrease blue light wave by controlling color temperature.
	Overdrive	Weak	Adjust the response time. (Boost can only enable in Freesync off mode)
Medium			
Strong			
Boost (Motion picture response time 1ms)			
Off			
FreeSync	ON/OFF	Adjust the FreeSync.	
Frame Counter	Off / Right-Up / Right-Down / Left-Down / Left-Up	Display vertical scanning frequency	
MBR	0-20	MBR (Motion Blur Reduction) will provide 0 – 20 levels for adjusting visible motion blur.	

Note:

Boost or MBR must be above 75Hz refresh rate to start.

Extra



1 Press  **MENU** (Menu) to display menu.

2 Press < or > to select  (Luminance), and press  to enter.

3 Press < or > to select submenu.

4 Press < or > to adjust.

5 Press  to exit.

	Input Select	Auto/D-SUB/HDMI1/HDMI2/DP	Select input signal source.
	Auto Config.	Yes / No	Auto adjust the picture to default.
	Off Timer	0-24 hrs	Select DC off time.
	Image Ratio	Wide	Select image ratio for display.
		4:3	
		1:1	
		17" (4:3)	
		19" (4:3)	
		19" (5:4) (27G2/27G2U)	
		19"W (16:10)	
		21.5"W (16:9)	
22"W (16:10) (27G2/27G2U)			
23"W (16:9)			
23.6"W (16:9) (27G2/27G2U)			
24"W (16:9) (27G2/27G2U)			
DDC/CI	Yes / No	Turn on or off DDC/CI Support.	
Reset	Yes / No	Reset the menu to default.	

Exit



1 Press  **MENU** (Menu) to display menu.

2 Press < or > to select  (Luminance), and press  to enter.

3 Press  to exit.

LED Indicator

Status	LED Color
Full Power Mode	White
Power Saving	Orange

Driver

G-Menu



Welcome to “G-Menu” software by AOC. G-Menu makes it easy to adjust your monitor display setting by using on screen menus instead of the OSD button on the monitor. To complete installation, please follow the installation guide. The software Supported operating systems: Windows 10, Windows 8, Windows 7.

Note:

Features are not available for all models.

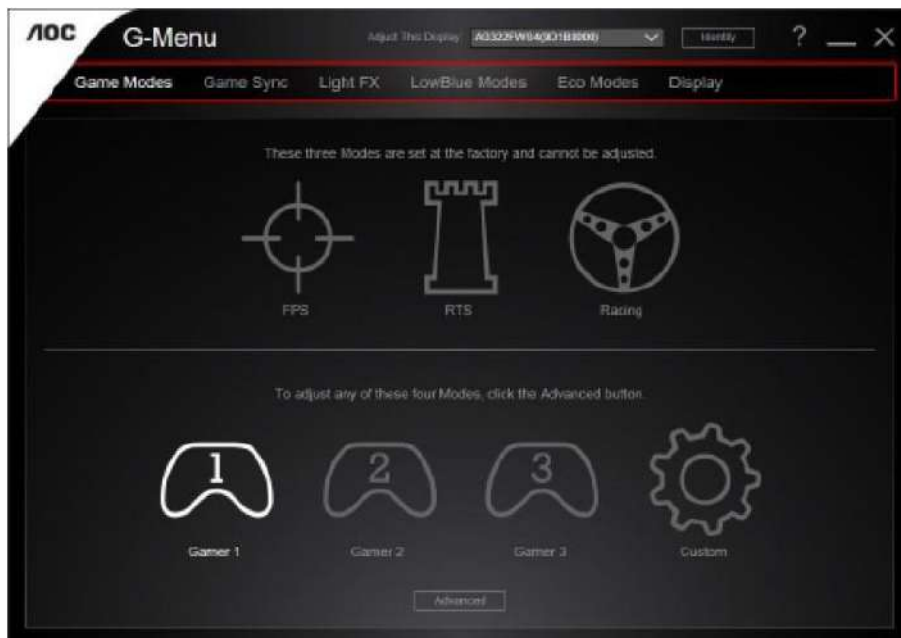

e-Saver



Welcome to use AOC e-Saver monitor power management software! The AOC e-Saver features Smart Shutdown functions for your monitors, allows your monitor to timely shutdown when PC unit is at any status (On, Off, Sleep or Screen Saver); the actual shutdown time depends on your preferences (see example below).

Please click on "driver/e-Saver/setup.exe" to start installing the e-Saver software, follow the install wizard to complete software installation.

Under each of the four PC statuses, you may choose the desired time (in minutes) from the pull-down menu for your monitor to automatically shutdown. The example below illustrated:

- 1) The monitor will never shutdown when the PC is powered on.
- 2) The monitor will automatically shutdown 5 minutes after the PC is powered off.
- 3) The monitor will automatically shutdown 10 minutes after the PC is in sleep/stand-by mode.
- 4) The monitor will automatically shutdown 20 minutes after the screen saver appears.

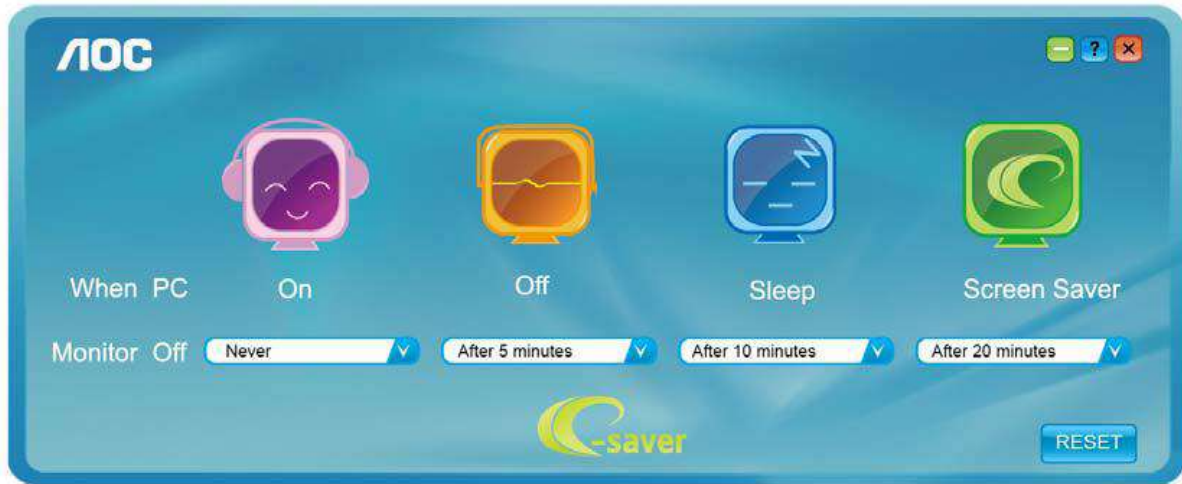

You can click "RESET" to set the e-Saver to its default settings like below.

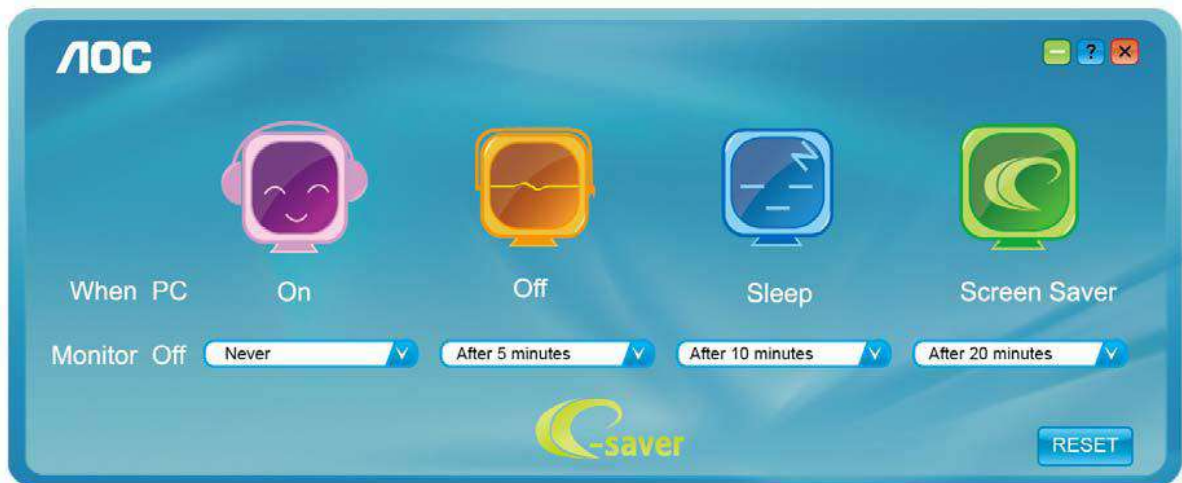

Screen+



Welcome to "Screen+" software by AOC. Screen+ software is a desktop screen splitting tool; it splits the desktop into different panels, and each panel displays a different window. You only need to drag the window to a corresponding panel when you want to access it. It supports multiple monitor display to make your task easier. Please follow the installation software to install it.

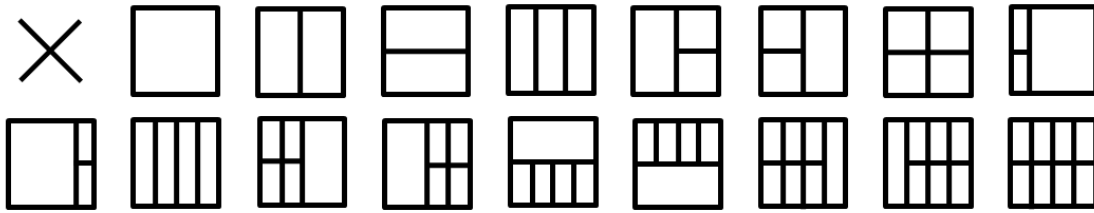

Troubleshoot

Problem & Question	Possible Solutions
Power LED Is Not ON	Make sure the power button is ON and the Power Cord is properly connected to a grounded power outlet and to the monitor.
No images on the screen	<ul style="list-style-type: none"> ● Is the power cord connected properly? Check the power cord connection and power supply. ● Is the cable connected correctly? (Connected using the D-sub cable) Check the DB-15 cable connection. (Connected using the DVI cable) Check the DVI cable connection. (Connected using the HDMI cable) Check the HDMI cable connection. (Connected using the DP cable) Check the DP cable connection. * DVI/HDMI/DP input is not available on every model. ● If the power is on, reboot the computer to see the initial screen (the login screen), which can be seen. If the initial screen (the login screen) appears, boot the computer in the applicable mode (the safe mode for Windows 7/8/10) and then change the frequency of the video card. (Refer to the Setting the Optimal Resolution) If the initial screen (the login screen) does not appear, contact the Service Center or your dealer. ● Can you see "Input Not Supported" on the screen? You can see this message when the signal from the video card exceeds the maximum resolution and frequency that the monitor can handle properly. Adjust the maximum resolution and frequency that the monitor can handle properly. ● Make sure the AOC Monitor Drivers are installed.
Picture Is Fuzzy & Has Ghosting Shadowing Problem	Adjust the Contrast and Brightness Controls. Press to auto adjust. Make sure you are not using an extension cable or switch box. We recommend plugging the monitor directly to the video card output connector on the back.
Picture Bounces, Flickers Or Wave Pattern Appears In The Picture	Move electrical devices that may cause electrical interference as far away from the monitor as possible. Use the maximum refresh rate your monitor is capable of at the resolution you are using.

<p>Monitor Is Stuck In Active Off-Mode"</p>	<p>The Computer Power Switch should be in the ON position. The Computer Video Card should be snugly fitted in its slot. Make sure the monitor's video cable is properly connected to the computer. Inspect the monitor's video cable and make sure no pin is bent. Make sure your computer is operational by hitting the CAPS LOCK key on the keyboard while observing the CAPS LOCK LED. The LED should either turn ON or OFF after hitting the CAPS LOCK key.</p>
<p>Missing one of the primary colors (RED, GREEN, or BLUE)</p>	<p>Inspect the monitor's video cable and make sure that no pin is damaged. Make sure the monitor's video cable is properly connected to the computer.</p>
<p>Screen image is not centered or sized properly</p>	<p>Adjust H-Position and V-Position or press hot-key (AUTO).</p>
<p>Picture has color defects (white does not look white)</p>	<p>Adjust RGB color or select desired color temperature.</p>
<p>Horizontal or vertical disturbances on the screen</p>	<p>Use Windows7/8/10 shut-down mode to adjust CLOCK and PHASE. Press to auto-adjust.</p>

Specification

General Specification

Panel	Model name	24G2/24G2U	
	Driving system	TFT Color LCD	
	Viewable Image Size	60.5 cm diagonal	
	Pixel pitch	0.2745(H)mm x 0.2745(V)mm	
	Video	R, G, B Analog Interface & HDMI Interface & DP Interface	
	Separate Sync.	H/V TTL	
Others	Horizontal scan range	30~160KHz	
	Horizontal scan Size(Maximum)	527.04mm	
	Vertical scan range	48-144Hz	
	Vertical scan Size(Maximum)	296.46mm	
	Optimal preset resolution	1920x1080@60Hz	
	Max resolution	1920x1080@60Hz(D-SUB) 1920x1080@144Hz(HDMI、DP)	
	Plug & Play	VESA DDC2B/CI	
	Power Source	100-240V~,50/60Hz	
	Power Consumption	Typical (Brightness = 90,Contrast = 50) (Brightness = 100,Contrast = 100)	21W ≤ 30W
	Power saving	≤0.3W	
Physical Characteristics	Connector Type	D-Sub/ HDMI/DP/Earphone out/ Line in(24G2U)/USB(24G2U)	
	Signal Cable Type	Detachable	
Environmental	Temperature:	Operating	0° to 40°C
		Non-Operating	-25° to 55°C
	Humidity:	Operating	10% to 85% (non-condensing)
		Non-Operating	5% to 93% (non-condensing)
	Altitude:	Operating	0~ 5000m(0~ 16404 ft)
		Non-Operating	0~ 12192m (0~ 40000 ft)

Panel	Model name	27G2/27G2U	
	Driving system	TFT Color LCD	
	Viewable Image Size	68.6 cm diagonal	
	Pixel pitch	0.3114(H)mm x 0.3114(V)mm	
	Video	R, G, B Analog Interface & HDMI Interface & DP Interface	
	Separate Sync.	H/V TTL	
Others	Horizontal scan range	30~160KHz	
	Horizontal scan Size(Maximum)	597.888mm	
	Vertical scan range	48-144Hz	
	Vertical scan Size(Maximum)	336.312mm	
	Optimal preset resolution	1920x1080@60Hz	
	Max resolution	1920x1080@60Hz(D-SUB) 1920x1080@144Hz(HDMI、DP)	
	Plug & Play	VESA DDC2B/CI	
	Power Source	100-240V~,50/60Hz	
	Power Consumption	Typical (Brightness = 90,Contrast = 50)	28W
Max.(Brightness = 100,Contrast = 100)		≤ 36W	
Power saving		≤0.3W	
Physical Characteristics	Connector Type	D-Sub/ HDMI/DP/Earphone out/ Line in (24G2U/27G2U) /USB(24G2U/27G2U)	
	Signal Cable Type	Detachable	
Environmental	Temperature:	Operating	0° to 40°C
		Non-Operating	-25° to 55°C
	Humidity:	Operating	10% to 85% (non-condensing)
		Non-Operating	5% to 93% (non-condensing)
	Altitude:	Operating	0~ 5000m(0~ 16404 ft)
		Non-Operating	0~ 12192m (0~ 40000 ft)

Preset Display Modes

Standard	Resolution	H. Frequency (kHz)	V. Frequency (Hz)
VGA	640x480@60Hz	31.469	59.94
VGA	640x480@67Hz	35	66.667
VGA	640x480@72Hz	37.861	72.809
VGA	640x480@75Hz	37.5	75
VGA	640x480@100Hz	51.08	99.769
VGA	640x480@120Hz	61.91	119.518
DOS MODE	720x400@70Hz	31.469	70.087
DOS MODE	720x480@60Hz	29.855	59.710
SD	720x576@50Hz	31.25	50
SVGA	800x600@56Hz	35.156	56.25
SVGA	800x600@60Hz	37.879	60.317
SVGA	800x600@72Hz	48.077	72.188
SVGA	800x600@75Hz	46.875	75
SVGA	800x600@100Hz	63.684	99.662
SVGA	800x600@120Hz	76.302	119.97
SVGA	832x624@75Hz	49.725	74.551
XGA	1024x768@60Hz	48.363	60.004
XGA	1024x768@70Hz	56.476	70.069
XGA	1024x768@75Hz	60.023	75.029
XGA	1024x768@100Hz	81.577	99.972
XGA	1024x768@120Hz	97.551	119.989
WXGA+	1440x900@60Hz	55.935	59.887
SXGA	1280x1024@60Hz	63.981	60.02
SXGA	1280x1024@75Hz	79.975	75.025
HD	1280x720@50Hz	37.071	49.827
HD	1280x720@60Hz	45	60
HD	1280x1080@60Hz	67.173	59.976
Full HD	1920x1080@60Hz	67.5	60
Full HD	1920x1080@100Hz	113.21	99.93
Full HD	1920x1080@120Hz	137.26	119.982
Full HD	1920x1080@144Hz	158.1	144

Pin Assignments

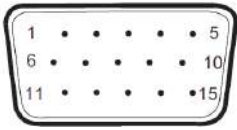

15-Pin Color Display Signal Cable

Pin No.	Signal Name	Pin No.	Signal Name
1	Video-Red	9	+5V
2	Video-Green	10	Ground
3	Video-Blue	11	N.C.
4	N.C.	12	DDC-Serial data
5	Detect Cable	13	H-sync
6	GND-R	14	V-sync
7	GND-G	15	DDC-Serial clock
8	GND-B		

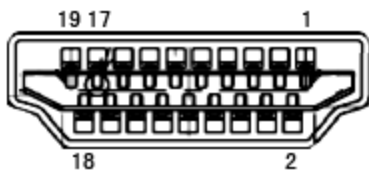

19-Pin Color Display Signal Cable

Pin No.	Signal Name	Pin No.	Signal Name
1	TMDS Data 2+	11	TMDS Clock Shield
2	TMDS Data 2 Shield	12	TMDS Clock
3	TMDS Data 2	13	CEC
4	TMDS Data 1+	14	Reserved (N.C. on device)
5	TMDS Data 1Shield	15	SCL
6	TMDS Data 1	16	SDA
7	TMDS Data 0+	17	DDC/CEC Ground
8	TMDS Data 0 Shield	18	+5V Power
9	TMDS Data 0	19	Hot Plug Detect
10	TMDS Clock +		

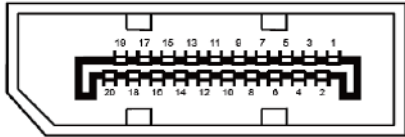

20-Pin Color Display Signal Cable

Pin No.	Signal Name	Pin No.	Signal Name
1	ML Lane 3(n)	11	GND
2	GND	12	ML Lane 0(p)
3	ML Lane 3(p)	13	CONFIG1
4	ML Lane 2(n)	14	CONFIG2
5	GND	15	AUX CH(p)
6	ML Lane 2(p)	16	GND
7	ML Lane 1(n)	17	AUX CH(n)
8	GND	18	Hot Plug Detect
9	ML Lane 1(p)	19	Return OP PWR
10	ML Lane 0(n)	20	DP PWR

Plug and Play

Plug & Play DDC2B Feature

This monitor is equipped with VESA DDC2B capabilities according to the VESA DDC STANDARD. It allows the monitor to inform the host system of its identity and, depending on the level of DDC used, communicate additional information about its display capabilities.

The DDC2B is a bi-directional data channel based on the I2C protocol. The host can request EDID information over the DDC2B channel.