

AGON



**LCD Monitor
User Manual**

AG405UXC

AOC

www.aoc.com

©2022 AOC. All Rights Reserved.

HDMI[®]
HIGH-DEFINITION MULTIMEDIA INTERFACE

| | |
|-------------------------------------|----|
| Safety | 1 |
| National Conventions | 1 |
| Power | 2 |
| Installation | 3 |
| Cleaning | 4 |
| Other | 5 |
| Setup | 6 |
| Contents in Box | 6 |
| Setup Stand & Base | 7 |
| Adjusting the monitor | 8 |
| Connecting the Monitor | 9 |
| AMD FreeSync Premium function | 10 |
| HDR | 11 |
| KVM function | 12 |
| Adjusting | 14 |
| Hotkeys | 14 |
| OSD Key Guide (Menu) | 16 |
| OSD Setting | 18 |
| Game Setting | 19 |
| Luminance | 21 |
| PIP Setting | 22 |
| Color Setup | 24 |
| Extra | 25 |
| OSD Setup | 27 |
| LED Indicator | 28 |
| Troubleshoot | 29 |
| Specification | 30 |
| General Specification | 30 |
| Preset Display Modes | 31 |
| Pin Assignments | 32 |
| Plug and Play | 33 |

Safety

National Conventions

The following subsections describe notational conventions used in this document.

Notes, Cautions, and Warnings

Throughout this guide, blocks of text may be accompanied by an icon and printed in bold type or in italic type. These blocks are notes, cautions, and warnings, and they are used as follows:



NOTE: A NOTE indicates important information that helps you make better use of your computer system.





CAUTION: A CAUTION indicates either potential damage to hardware or loss of data and tells you how to avoid the problem.





WARNING: A WARNING indicates the potential for bodily harm and tells you how to avoid the problem. Some warnings may appear in alternate formats and may be unaccompanied by an icon. In such cases, the specific presentation of the warning is mandated by regulatory authority.

Power

 The monitor should be operated only from the type of power source indicated on the label. If you are not sure of the type of power supplied to your home, consult your dealer or local power company.

 The monitor is equipped with a three-pronged grounded plug, a plug with a third (grounding) pin. This plug will fit only into a grounded power outlet as a safety feature. If your outlet does not accommodate the three-wire plug, have an electrician install the correct outlet, or use an adapter to ground the appliance safely. Do not defeat the safety purpose of the grounded plug.

 Unplug the unit during a lightning storm or when it will not be used for long periods of time. This will protect the monitor from damage due to power surges.

 Do not overload power strips and extension cords. Overloading can result in fire or electric shock.

 To ensure satisfactory operation, use the monitor only with UL listed computers which have appropriate configured receptacles marked between 100-240V AC, Min. 5A.

 The wall socket shall be installed near the equipment and shall be easily accessible.

Installation

! Do not place the monitor on an unstable cart, stand, tripod, bracket, or table. If the monitor falls, it can injure a person and cause serious damage to this product. Use only a cart, stand, tripod, bracket, or table recommended by the manufacturer or sold with this product. Follow the manufacturer's instructions when installing the product and use mounting accessories recommended by the manufacturer. A product and cart combination should be moved with care.

! Never push any object into the slot on the monitor cabinet. It could damage circuit parts causing a fire or electric shock. Never spill liquids on the monitor.

! Do not place the front of the product on the floor.

! If you mount the monitor on a wall or shelf, use a mounting kit approved by the manufacturer and follow the kit instructions.

! To avoid potential damage, for example the panel peeling from the bezel, ensure that the monitor does not tilt downward by more than -5 degrees. If the -5 degree downward tilt angle maximum is exceeded, the monitor damage will not be covered under warranty.

! Leave some space around the monitor as shown below. Otherwise, air-circulation may be inadequate hence overheating may cause a fire or damage to the monitor.

See below the recommended ventilation areas around the monitor when the monitor is installed on the stand:

Installed with stand

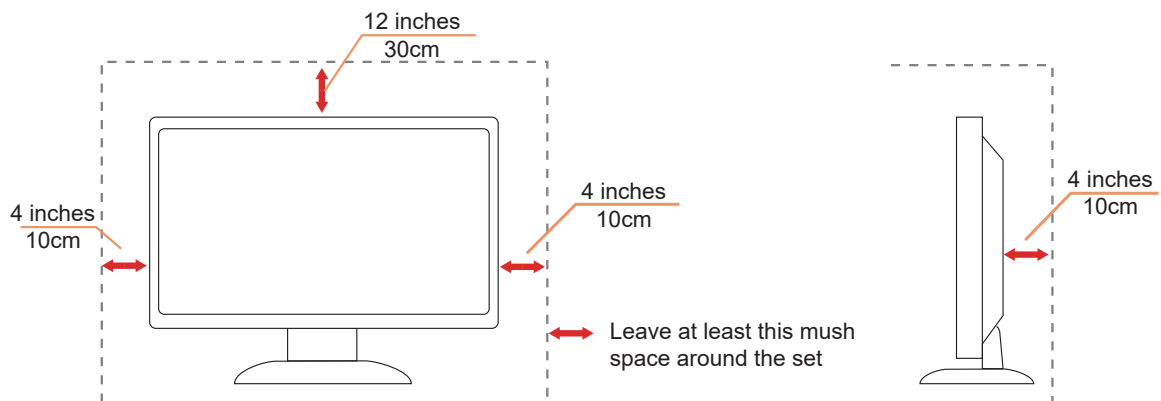

Cleaning

⚠ Clean the cabinet regularly with a water-dampened, soft cloth.

⚠ When cleaning use a soft cotton or microfiber cloth. The cloth should be damp and almost dry, do not allow liquid into the case.

⚠ Please disconnect the power cord before cleaning the product.



Other

 If the product is emitting a strange smell, sound or smoke, disconnect the power plug IMMEDIATELY and contact a Service Center.

 Make sure that the ventilating openings are not blocked by a table or curtain.

 Do not engage the LCD monitor in severe vibration or high impact conditions during operation.

 Do not knock or drop the monitor during operation or transportation.

 The USB Type-C port could only be connected to specify equipment with fire enclosure in compliance with IEC 62368-1 or IEC 60950-1.

Setup

Contents in Box

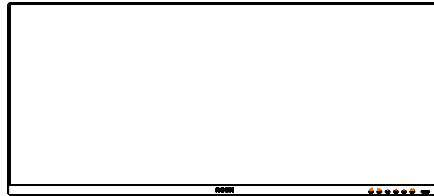

*



WW QSG

*



Warranty card



Stand



Base



Screwdriver



Stand Screws



Remote control



Batteries



Power Cable

*



DP Cable

*



HDMI Cable

*



USB upstream Cable

*



USB C-C

* Not all signal cables will be provided for all countries and regions. Please check with the local dealer or AOC branch office for confirmation.

Setup Stand & Base

Please setup or remove the base following the steps as below.

Setup:

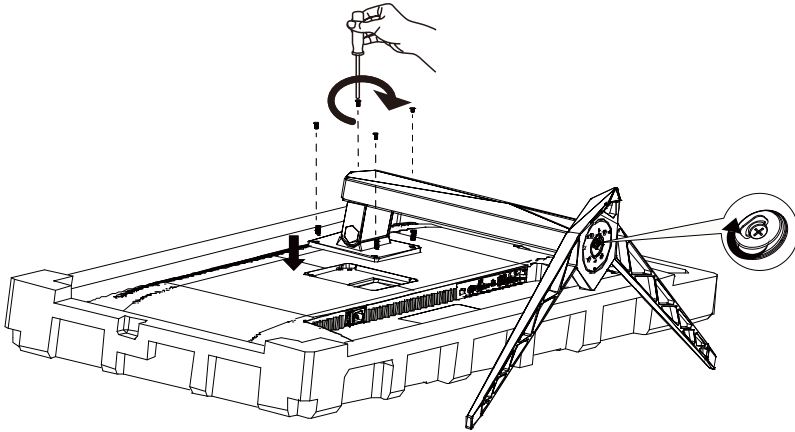

Remove:

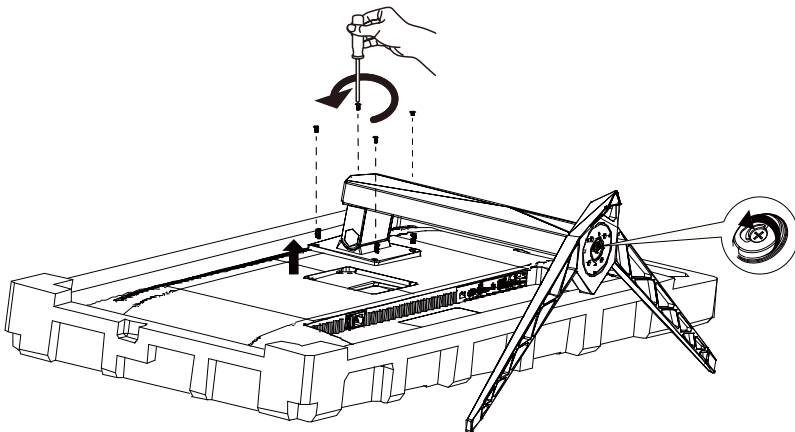

Adjusting the monitor

For optimal viewing it is recommended to look at the full face of the monitor, then adjust the monitor's angle to your own preference.

Hold the stand so you will not topple the monitor when you change the monitor's angle.

You are able to adjust the monitor as below:

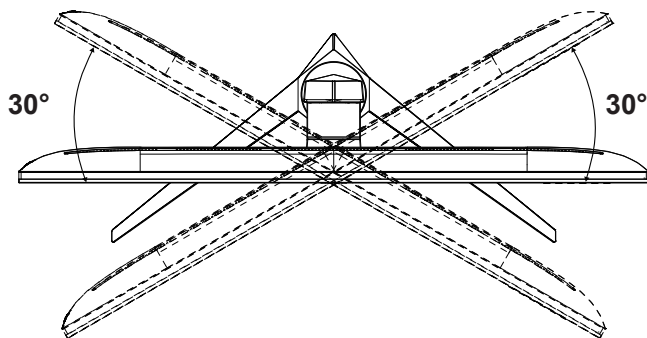
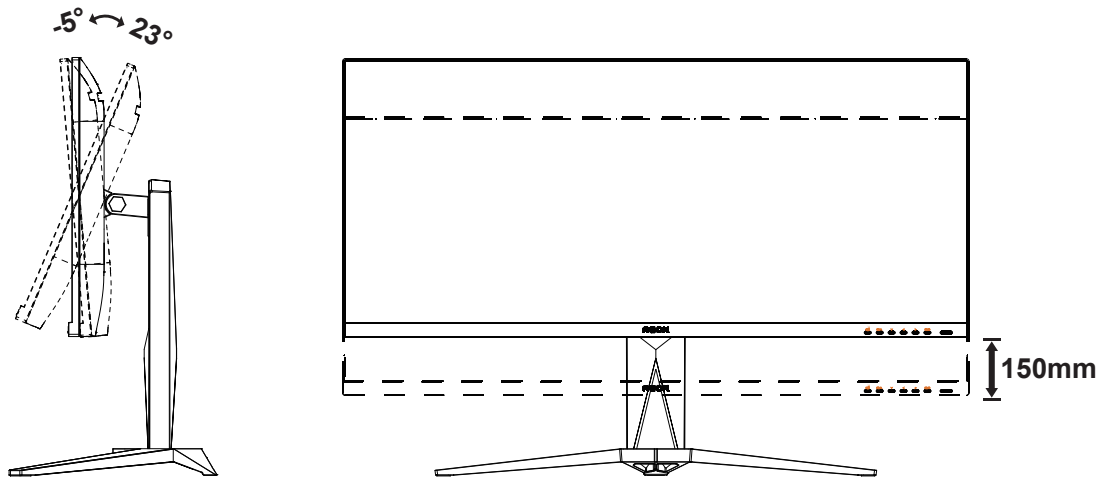

NOTE:

Do not touch the LCD screen when you change the angle. Touching the LCD screen may cause damage.

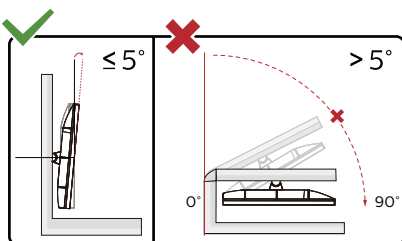

* Display design may differ from those illustrated.

WARNING:

- To avoid potential screen damage, such as panel peeling, ensure that the monitor does not tilt downward by more than -5 degrees.
- Do not press the screen while adjusting the angle of the monitor. Grasp only the bezel.

Connecting the Monitor

Cable Connections In Back of Monitor and Computer:

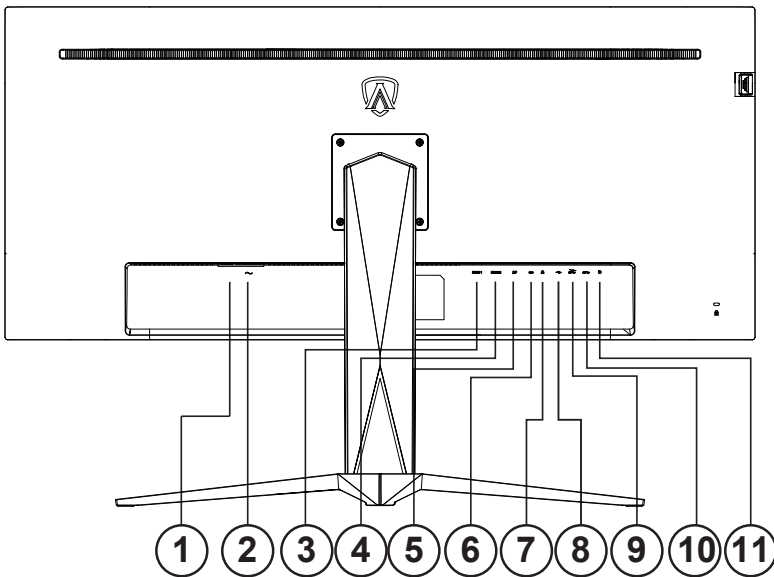

1. Power Switch
2. Power
3. HDMI 1
4. HDMI 2
5. DP
6. USB C
7. Earphone
8. USB upstream
9. USB3.2 Gen1 downstream + fast charging
USB3.2 Gen1 downstream x1
10. USB3.2 Gen1 downstream x2
11. Quick Switch port

Connect to PC

1. Connect the power cord to the back of the display firmly.
2. Turn off your computer and unplug its power cable.
3. Connect the display signal cable to the video connector on the back of your computer.
4. Plug the power cord of your computer and your display into a nearby outlet.
5. Turn on your computer and display.

If your monitor displays an image, installation is complete. If it does not display an image, please refer Troubleshooting.

To protect equipment, always turn off the PC and LCD monitor before connecting.

AMD FreeSync Premium function

1. AMD FreeSync Premium function is working with DP/HDMI/USB C
2. Compatible Graphics Card: Recommend list is as the below, also could be checked by visiting www.AMD.com

Graphics Cards

- Radeon™ RX Vega series
- Radeon™ RX 500 series
- Radeon™ RX 400 series
- Radeon™ R9/R7 300 series (excluding R9 370/X)
- Radeon™ Pro Duo (2016 edition)
- Radeon™ R9 Nano
- Radeon™ R9 Fury series
- Radeon™ R9/R7 200 series (excluding R9 270/X, R9 280/X)

Processors

- AMD Ryzen™ 7 2700U
- AMD Ryzen™ 5 2500U
- AMD Ryzen™ 5 2400G
- AMD Ryzen™ 3 2300U
- AMD Ryzen™ 3 2200G
- AMD PRO A12-9800
- AMD PRO A12-9800E
- AMD PRO A10-9700
- AMD PRO A10-9700E
- AMD PRO A8-9600
- AMD PRO A6-9500
- AMD PRO A6-9500E
- AMD PRO A12-8870
- AMD PRO A12-8870E
- AMD PRO A10-8770
- AMD PRO A10-8770E
- AMD PRO A10-8750B
- AMD PRO A8-8650B
- AMD PRO A6-8570
- AMD PRO A6-8570E
- AMD PRO A4-8350B
- AMD A10-7890K
- AMD A10-7870K
- AMD A10-7850K
- AMD A10-7800
- AMD A10-7700K
- AMD A8-7670K
- AMD A8-7650K
- AMD A8-7600
- AMD A6-7400K

HDR

It is compatible with input signals in HDR10 format.

The display may automatically activate the HDR function if the player and content are compatible. Please contact the device manufacturer and the content provider for information on the compatibility of your device and content. Please select "OFF" for the HDR function when you have no need for automatic activation function.

Note:

1. Only the HDMI interface is available and the DisplayPort interface cannot function in WIN10 version V1703.
2. The display resolution is set to 3440x1440@60Hz, and HDR is preset to ON. Under these conditions, the screen may slightly dim, indicating HDR has been activated.

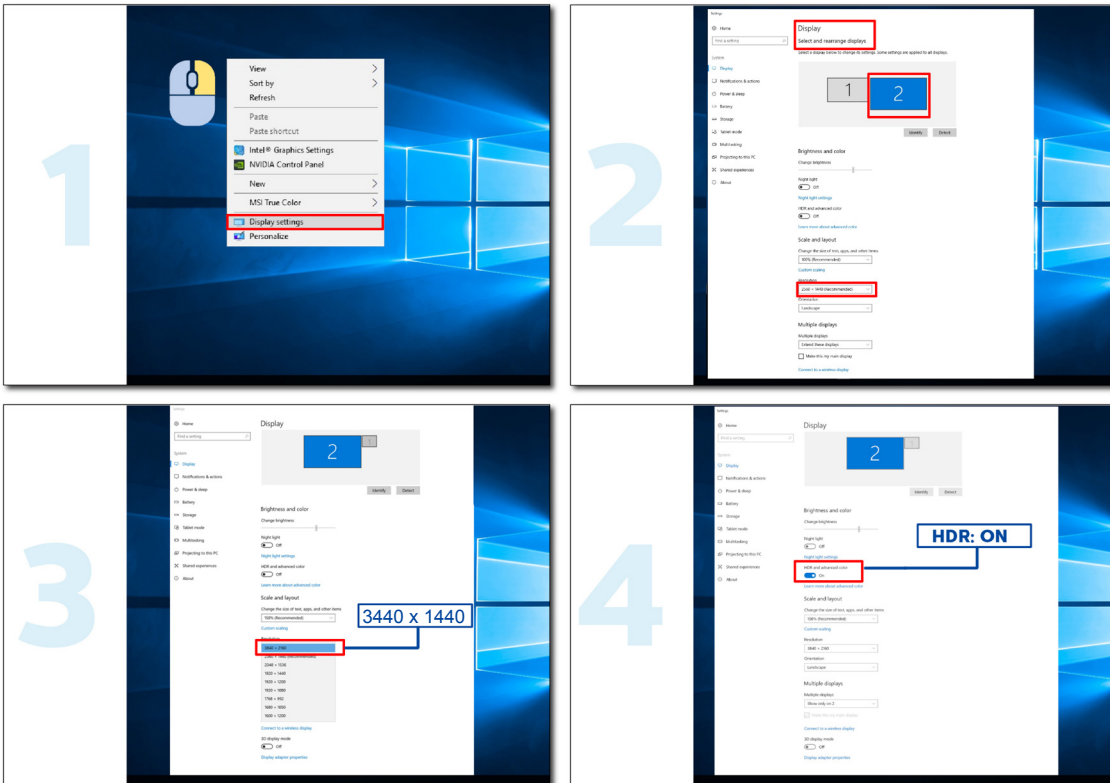

KVM function

What is KVM?

With KVM function, you can show two PCs, or two notebooks, or one PC and one notebook on one AOC monitor and control the two devices with one set of keyboard and mouse. Switch your control over your PC or notebook devices by choosing input signal source on “Input Select” of OSD menu.

How to use KVM?

Step 1: Please connect one device (PC or notebook) to monitor via USB C.

Step 2: Please connect the other device to monitor via HDMI or DisplayPort. Then please also connect this device to monitor with USB upstream.

Step 3: Please connect your peripherals (keyboard and mouse) to monitor via USB port.

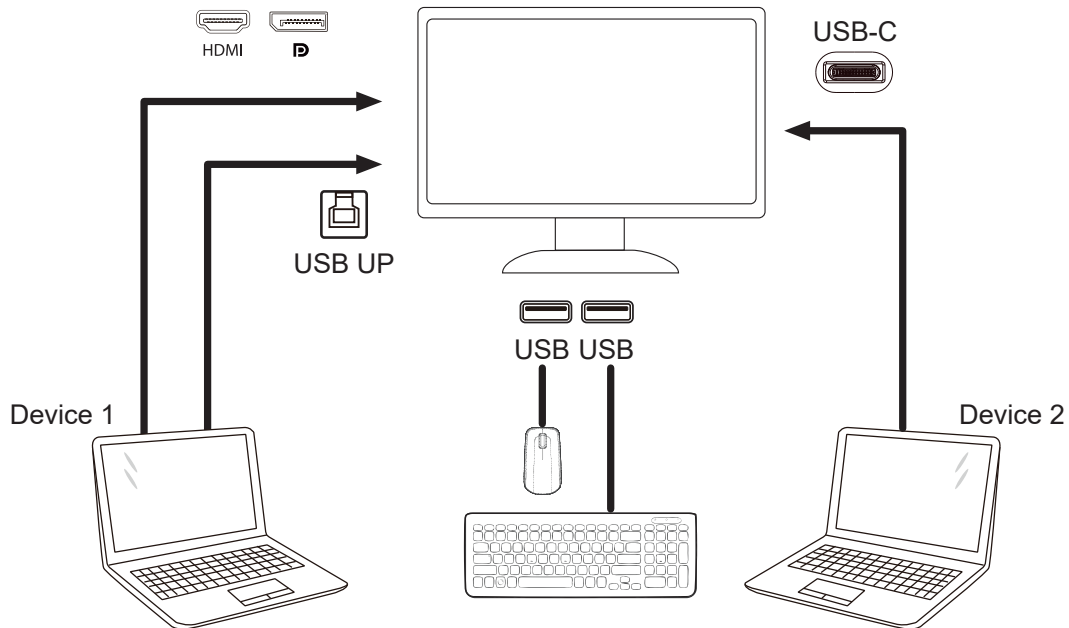

Note: Display design may differ from that illustrated

Step 4: Enter to OSD menu. Go to Extra page and select “Auto”, “USB C”, or “USB UP” of USB Selection tab.

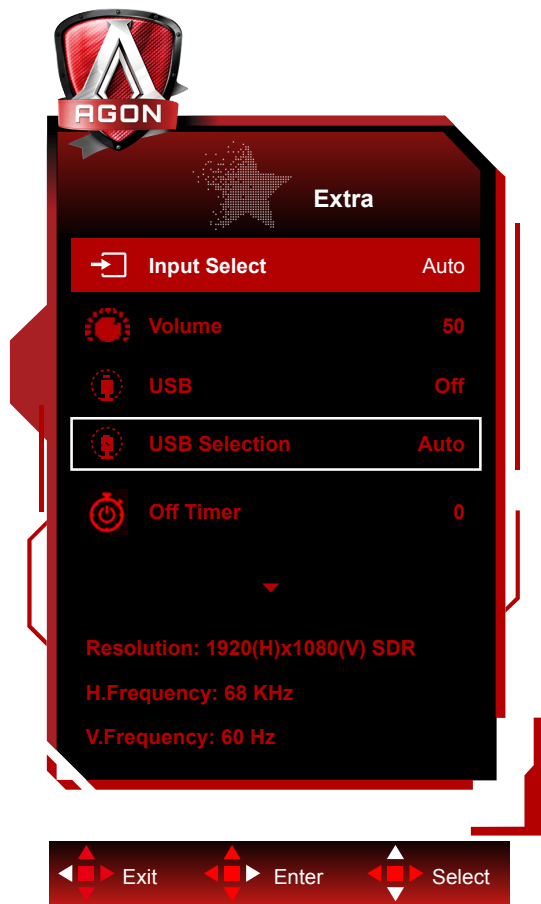

| USB Selection | Function Description |
|---------------|---|
| Auto | Auto selects USB C or USB Up depending on the input source. |
| USB C | Provides USB Hub function through Type-C cable. |
| USB Up | Provides USB Hub function through USB B cable. |

Adjusting

Hotkeys

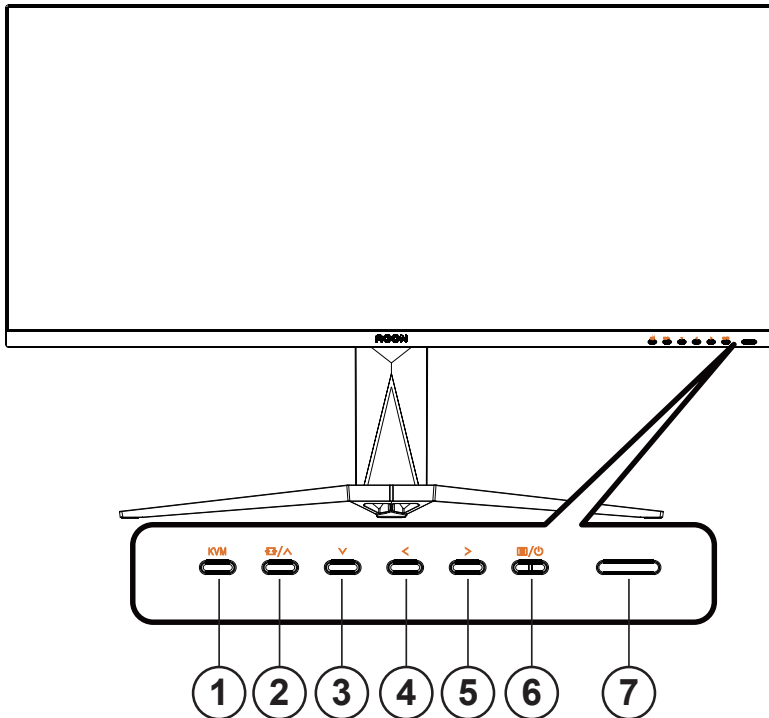

| | |
|---|-----------------------|
| 1 | KVM |
| 2 | Source/Up |
| 3 | Dial Point/Down |
| 4 | Game Mode/Left |
| 5 | Shadow Control /Right |
| 6 | Power/ Menu/Enter |
| 7 | LED |

Power/Menu/Enter

Press the Power button to turn on the monitor.

When there is no OSD, Press to display the OSD or confirm the selection. Press about 2 seconds to turn off the monitor.

Dial Point/Down

When there is no OSD, press Dial Point button to show / hide Dial Point.

Game Mode/Left

When there is no OSD, press " < Left" key to open game mode function, then press " < Left" or " > Right" key to select game mode (FPS, RTS, Racing, Gamer 1, Gamer 2 or Gamer 3) basing on the different game types.

Shadow Control/Right

When there is no OSD, Press Shadow Control button to active Shadow Control adjustment bar, Press “> Right” to adjust contrast for clear picture.

Source/Up

When the OSD is closed, press Source/Up button will be Source hot key function.

Description of the remote control buttons

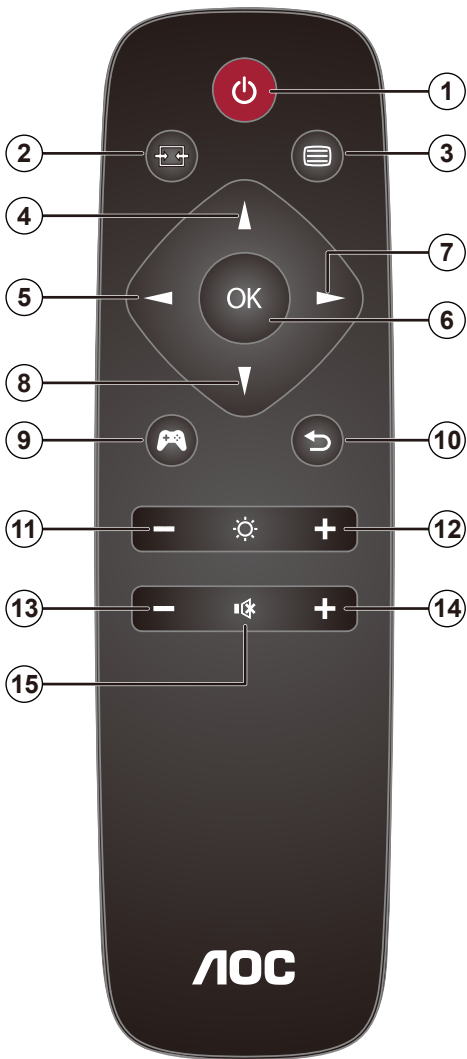

| | | |
|----|----|---|
| 1 | | Press to switch power on and off. |
| 2 | | Change the signal input source. |
| 3 | | Access the OSD menu. |
| 4 | | Adjust the OSD options upwards. |
| 5 | | Return to previous OSD level. |
| 6 | OK | Confirm the OSD adjustment/ Access the OSD menu. . |
| 7 | | Access the OSD menu. Confirm the OSD adjustment. |
| 8 | | Adjust the OSD options down. |
| 9 | | Open gaming mode. |
| 10 | | Exit OSD menu. |
| 11 | | Turn down the brightness |
| 12 | | Turn up the brightness |
| 13 | | Turn down the volume |
| 14 | | Turn up the volume |
| 15 | | Mute |

OSD Key Guide (Menu)



Enter : Use Enter key to enter the next OSD level
Move : Use Left / Up / Down key to move OSD selection
Exit : Use Right key to exit OSD



Enter : Use Enter key to enter the next OSD level
Move : Use Right / Up / Down key to move OSD selection
Exit : Use Left key to exit OSD



Enter : Use Enter key to enter the next OSD level
Move : Use Up / Down key to move OSD selection
Exit : Use Left key to exit OSD

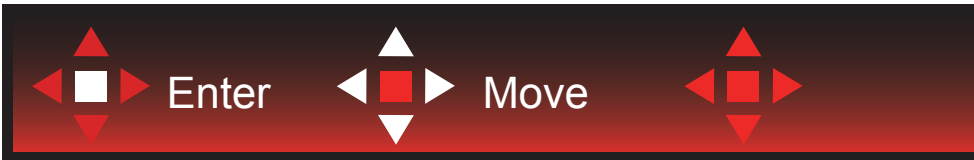

Move : Use Left / Right / Up / Down Key to move OSD selection



Exit : Use Left key to exit OSD to previous OSD level
Enter : Use Right key to enter next OSD level
Select : Use Up / Down key to move OSD selection



Enter : Use Enter key to apply the OSD setting and back to previous OSD level
Select : Use Down key to adjust OSD setting



Select : Use Up / Down key to adjust OSD setting



Enter : Use Enter key to exit OSD to previous OSD level
Select : Use Left / Right key to adjust OSD setting

OSD Setting

Basic and simple instruction on the control keys.





- 1). Press the MENU-button to activate the OSD window.
- 2). Follow Key Guide to move or select (adjust) OSD settings
- 3). OSD Lock/Unlock Function: To lock or unlock the OSD, press and hold the Down-button for 10s while OSD function is not active.

Notes:

- 1). If the product has only one signal input, the item of "Input Select" is disable to adjust.
- 2). ECO modes (except Standard mode), DCR and DCB mode, for these three states that only one state can exist.

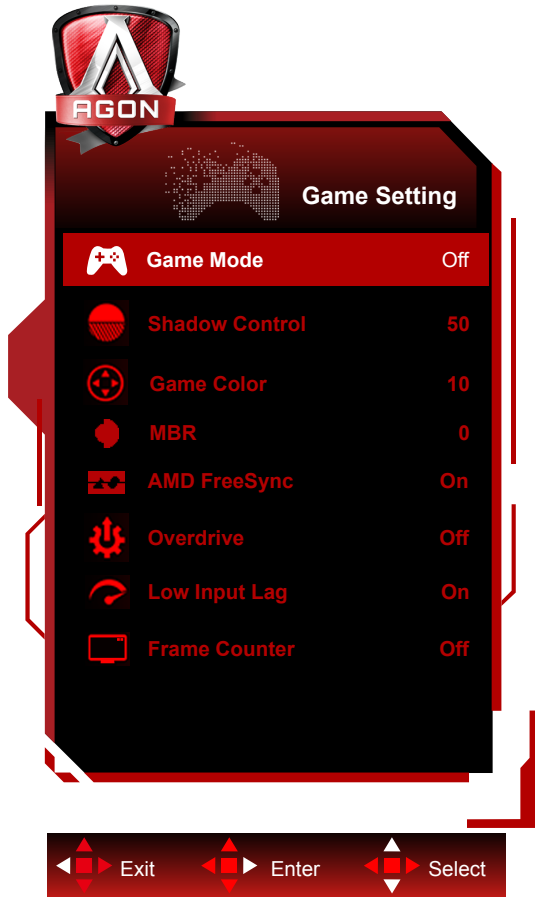
Game Setting



| | | | |
|---|----------------|--|--|
|  | Game Mode | Off | Turn off game mode. |
| | | FPS | For playing FPS (First Person Shooters) games. Improves dark theme black level details. |
| | | RTS | For playing RTS (Real Time Strategy). Improves the image quality. |
| | | Racing | For playing Racing games, Provides fastest response time and high color saturation. |
| | | Gamer 1 | User's preference settings saved as Gamer 1. |
| | | Gamer 2 | User's preference settings saved as Gamer 2. |
| | | Gamer 3 | User's preference settings saved as Gamer 3. |
| | Shadow Control | 0-100 | Shadow Control Default is 50, then end-user can adjust from 50 to 100 or 0 to increase contrast for clear picture. 1. If picture is too dark to be saw the detail clearly, adjusting from 50 to 100 for clear picture. 2. If picture is too white to be saw the detail clearly, adjusting from 50 to 0 for clear picture |
| | Game Color | 0-20 | Game Color will provide 0-20 level for adjusting saturation to get better picture. |
| | MBR | 0-20 | MBR (Motion Blur Reduction) Provides 0-20 levels of adjustments to reduce motion blur. Note: 1. The MBR function can be adjusted when AMD FreeSync Premium is turned off, the low input delay is turned on and the refresh rate is $\geq 75\text{Hz}$. 2. The brightness of the screen will decrease as the adjustment value increases. |
| AMD FreeSync | On / Off | Disable or Enable AMD FreeSync Premium. AMD FreeSync Premium Run Reminder: When the AMD FreeSync Premium feature is enabled, there may be flashing in some game environments. | |

| | | | |
|---------------|---|---|---|
| | Overdrive | Off | Adjust the response time. Note: 1. If the user adjusts OverDrive to “Strong” the displayed image may be blurred. Users can adjust the OverDrive level or turn it off according to their preferences. 2. The “Boost” function is optional when AMD FreeSync Premium is turned off, the low input delay is turned on, and the refresh rate is 1. The MBR function can be adjusted when AMD FreeSync Premium is turned off, the low input delay is turned on and the refresh rate is ≥75Hz ... 3. The screen brightness will decrease when the “Boost” function is turned on. |
| | | Weak | |
| | | Medium | |
| | | Strong | |
| | | Boost | |
| Low Input lag | On / Off | Turn off frame buffer to decrease input lag | |
| Frame Counter | Off / Right-Up / Right-Down / Left-Down / Left-Up | Instantly display the vertical frequency of the current signal. (Frame counter feature only works with AMD graphic card.) | |

Note:

When “HDR Mode” under “Image Setup” is set to “non-off”, the items “Game Mode”, “Shadow Control”, “Game Color” cannot be adjusted.

When “HDR” under “Image Setup” is set to “non-off”, the items “Game Mode”, “Shadow Control”, “Game Color”, “MBR” cannot be adjusted. “Boost” under “Overdrive” is not available.

Luminance

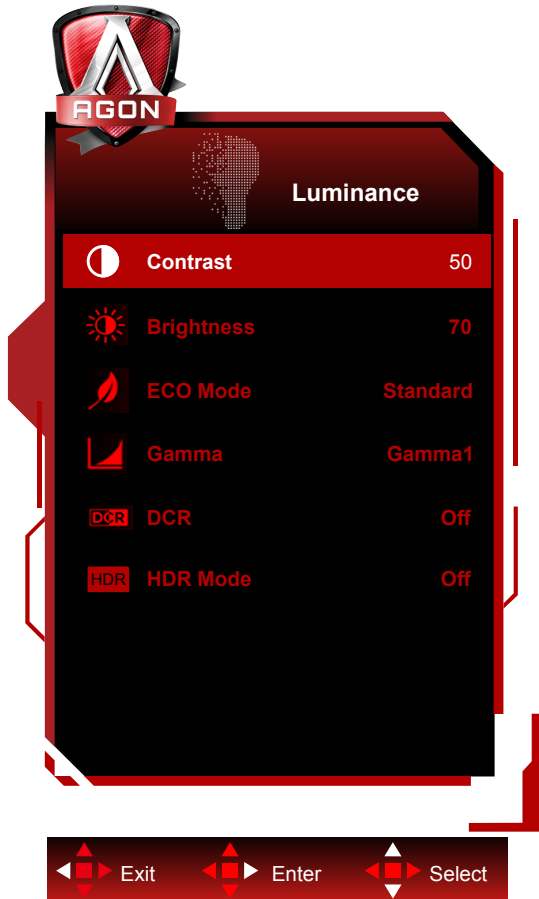

| | | | | |
|---|-------------|------------|---|---|
|  | Contrast | 0-100 | Contrast from Digital-register. | |
| | Brightness | 0-100 | Backlight Adjustment | |
| | Eco mode | Standard | | Standard Mode |
| | | Text | | Text Mode |
| | | Internet | | Internet Mode |
| | | Game | | Game Mode |
| | | Movie | | Movie Mode |
| | | Sports | | Sports Mode |
| | | Reading | | Reading Mode |
| | | Uniformity | | Uniformity Mode |
| | Gamma | Gamma1 | | Adjust to Gamma 1 |
| | | Gamma2 | | Adjust to Gamma 2 |
| | | Gamma3 | | Adjust to Gamma 3 |
| | DCR | Off/On | Disable/ Enable dynamic contrast ratio | |
| | HDR | Off | | Set the HDR profile according to your usage requirements. Note: When HDR is detected, the HDR option is displayed for adjustment. |
| | | DisplayHDR | | |
| HDR Picture | | | | |
| HDR Game | | | | |
| HDR Mode | Off | | Optimized for the color and contrast of the picture, which will simulate showing the HDR effect. Note: When HDR is not detected, the HDR Mode option is displayed for adjustment. | |
| | HDR Picture | | | |
| | HDR Movie | | | |
| | HDR Game | | | |

Note:

1. When “HDR Mode” under “Luminance” is set to non-off, “Contrast”, “Eco Mode” and “Gamma” can’t be adjusted.
2. When “HDR” under “Luminance” is set to non-off, all items under “Luminance” can’t be adjusted.

PIP Setting

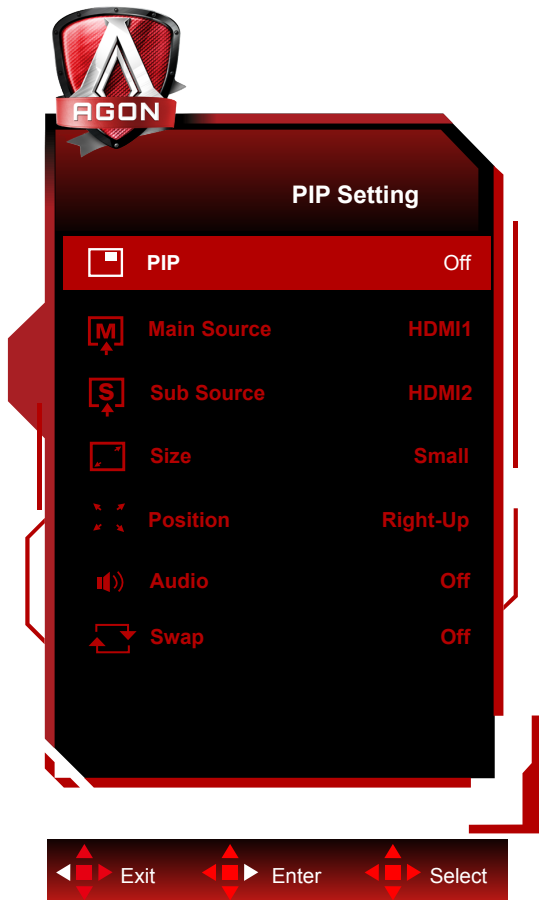

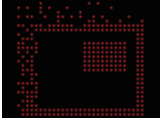
| | | | | |
|---|-----------------|------------------------|-------------------------------|--------------------------------|
|  | PIP Setting | Off / PIP / PBP | Disable or Enable PIP or PBP. | |
| | Main Source | | Select main screen source. | |
| | Sub Source | | Select sub screen source. | |
| | Size | Small / Middle / Large | Select screen size. | |
| | Position | Right-up | | Set the screen location. |
| | | Right-down | | |
| | | Left-up | | |
| | | Left-down | | |
| | Audio | On: PIP Audio | | Disable or Enable Audio Setup. |
| | | Off: Main Audio | | |
| Swap | On: Swap | | Swap the screen source. | |
| | Off: non action | | | |

Note:

1. When “HDR” under “Brightness” is set to non-off state, all items under “PIP Setting” cannot be adjusted.
2. Under PBP, set the input signal resolution to 1920X2160@60Hz to obtain an ideal display effect.
3. When PIP/PBP is turned on, the DP signal source supports the maximum resolution of 3440x1440@120Hz; the HDMI signal source supports the maximum resolution of 3440x1440@100Hz.

| PIP/PBP | | Main source | | | |
|-------------|--------|-------------|-------|----|--------|
| | | HDMI1 | HDMI2 | DP | TYPE C |
| Sub -source | HDMI1 | V | V | V | V |
| | HDMI2 | V | V | V | V |
| | DP | V | V | V | V |
| | TYPE C | V | V | V | V |

*PxP color-related adjustments can only be operated by main, and sub is not supported.

So Main & sub will have different colors.

Color Setup

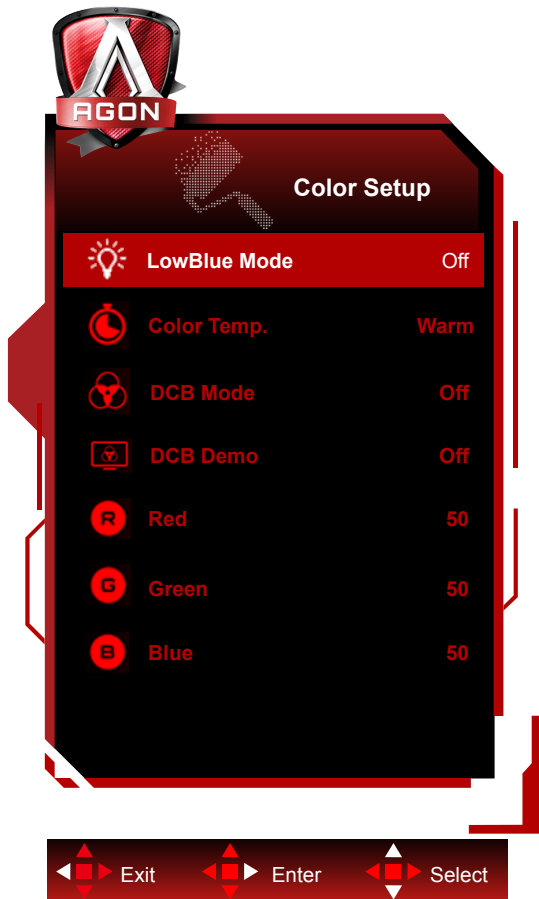

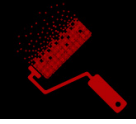

| | | | |
|---|--------------|--|--|
|  | LowBlue Mode | Off / Multimedia / Internet / Office / Reading | Decrease blue light wave by controlling color temperature. |
| | Color Temp. | Warm | Recall Warm Color Temperature from EEPROM. |
| | | Normal | Recall Normal Color Temperature from EEPROM. |
| | | Cool | Recall Cool Color Temperature from EEPROM. |
| | | sRGB | Recall sRGB Color Temperature from EEPROM. |
| | | User | Restore User Color Temperature from EEPROM. |
| | DCB Mode | Off | Disable or Enable Off Mode |
| | | Full Enhance | Enable Full Enhance Mode |
| | | Nature Skin | Enable Nature Skin Mode |
| | | Green Field | Enable Green Field Mode |
| | | Sky-blue | Enable Sky-blue Mode |
| | | AutoDetect | Enable AutoDetect Mode |
| | DCB Demo | On or Off | Disable or Enable Demo |
| Red | 0-100 | Red gain from Digital-register. | |
| Green | 0-100 | Green gain from Digital-register. | |
| Blue | 0-100 | Blue gain from Digital-register. | |

Note:

When "HDR/HDR Mode" under "Image Setup" is set to "non-off", all items under "Color Setup" cannot be adjusted.

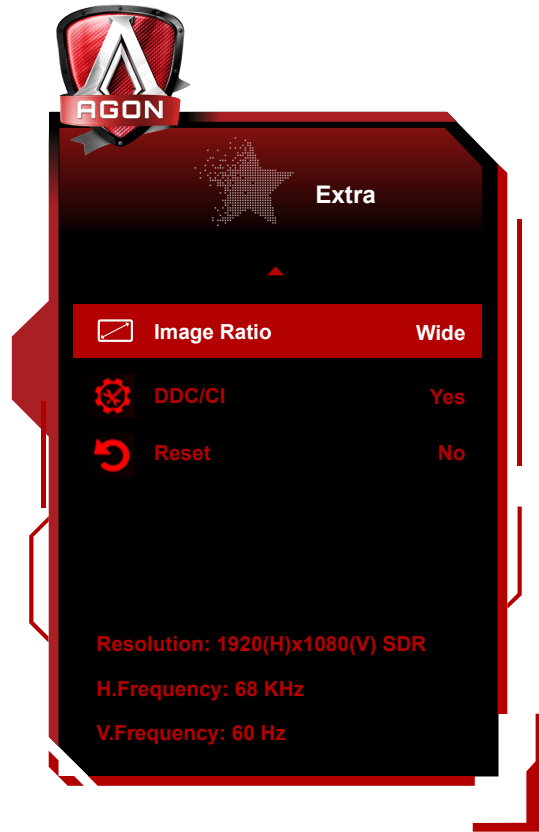
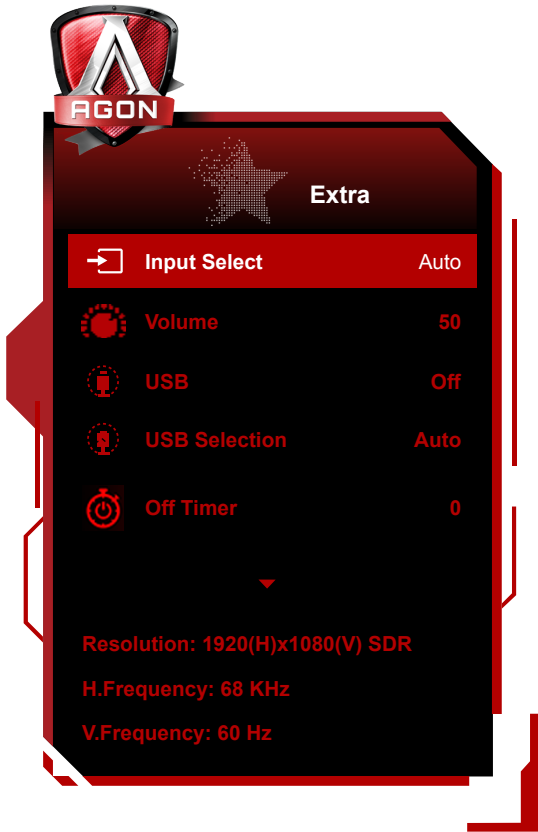
Extra



| | | | |
|---|---------------|--|--|
|  | Input Select | Auto / HDMI1 / HDMI2 /DP / USB C* | Select Input Signal Source. |
| | Volume | 0-100 | Adjust volume setting |
| | USB | Off/ High Resolution/High Data Speed | For model need to turn on/off USB power during power saving. The default USB setting is Off. If you want to connect USB-C device, please adjust the USB setting to High Resolution or High Data Speed. |
| | USB Selection | Auto / USB C / USB up | Auto : switch with display input source USB C / USB up : fix up stream not change with input source |
| | Off timer | 0-24hrs | Select DC off time |
| | Image Ratio | Wide / 4:3 / 1:1 / 17"(4:3)/19"(4:3) / 19"(5:4) /19"W(16:10) / 21.5"W(16:9) / 22"W(16:10) / 23"W(16:9) / 23.6"W(16:9) / 24"W(16:9) / 27"W(16:9) / 30"W(21:9) / 32"W(16:9) /34"W (21:9) | Select image ratio for display. |
| | DDC/CI | Yes or No | Turn ON/OFF DDC/CI Support |
| | Reset | Yes or No | Reset the menu to default |

*: The device needs to support USB C interface video transmission (DP Alt).

The USB C (DP Alt) function is turned off by default when it is used for the first time or after the OSD menu reset operation, and it can be turned on again by any of the following methods:

- 1). The display turns on and off 3 times in total.
- 2). The "USB" option under "OSD Settings" in the OSD menu is set to non-closed state.

OSD Setup

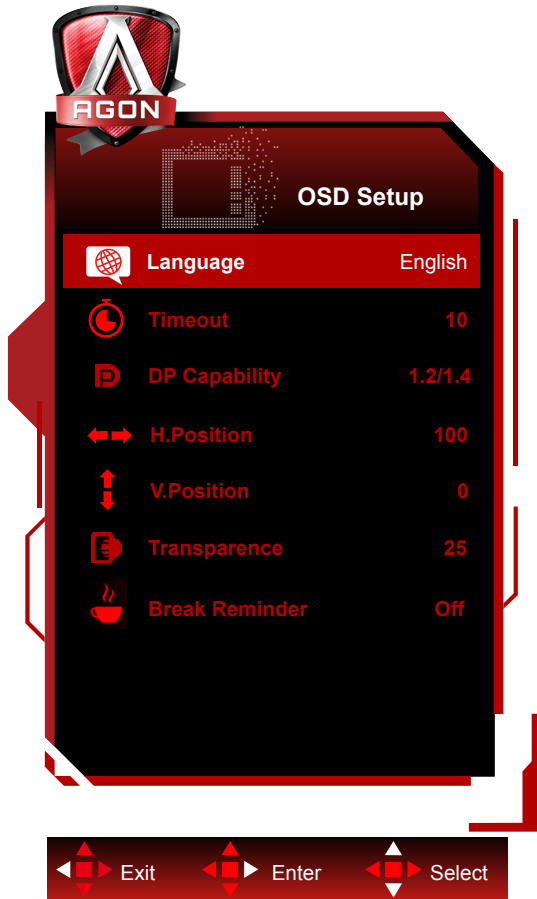

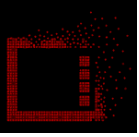
| | | | |
|---|----------------|-------------|--|
|  | Language | | Select the OSD language |
| | Timeout | 5-120 | Adjust the OSD Timeout |
| | DP Capability | 1.1/1.2/1.4 | please be noted that only DP1.2/DP1.4 support AMD FreeSync Premium Compatible function |
| | H. Position | 0-100 | Adjust the horizontal position of OSD |
| | V. Position | 0-100 | Adjust the vertical position of OSD |
| | Transparence | 0-100 | Adjust the transparence of OSD |
| | Break Reminder | On /Off | Break reminder if the user continuously work for more than 1hrs |

LED Indicator

| Status | LED Color |
|-----------------|------------------|
| Full Power Mode | White |
| Active-off Mode | White (blinking) |

Troubleshoot

| Problem & Question | Possible Solutions |
|---|---|
| Power LED Is Not ON | Make sure the power button is ON and the Power Cord is properly connected to a grounded power outlet and to the monitor. |
| No images on the screen | <ul style="list-style-type: none"> ● Is the power cord connected properly? Check the power cord connection and power supply. ● Is the video cable connected correctly? (Connected using the HDMI cable) Check the HDMI cable connection. (Connected using the DP cable) Check the DP cable connection. *HDMI/DP input is not available on every model. ● If the power is on, reboot the computer to see the initial screen (the login screen.) If the initial screen (the login screen) appears, boot the computer in the applicable mode (the safe mode for Windows 7/8/10) and then change the frequency of the video card. (Refer to the Setting the Optimal Resolution) If the initial screen (the login screen) does not appear, contact the Service Center or your dealer. ● Can you see "Input Not Supported" on the screen? You can see this message when the signal from the video card exceeds the maximum resolution and frequency that the monitor can handle properly. Adjust the maximum resolution and frequency that the monitor can handle properly. ● Make sure the AOC Monitor Drivers are installed. |
| Picture Is Fuzzy & Has Ghosting Shadowing Problem | Adjust the Contrast and Brightness Controls. Press hot-key (AUTO) to auto-adjust. Make sure you are not using an extension cable or switch box. We recommend plugging the monitor directly to the video card output connector on the back. |
| Picture Bounces, Flickers Or Wave Pattern Appears In The Picture | Move electrical devices that may cause electrical interference as far away from the monitor as possible. Use the maximum refresh rate your monitor is capable of at the resolution you are using. |
| Monitor Is Stuck In Active Off-Mode" | The Computer Power Switch should be in the ON position. The Computer Video Card should be snugly fitted in its slot. Make sure the monitor's video cable is properly connected to the computer. Inspect the monitor's video cable and make sure no pin is bent. Make sure your computer is operational by hitting the CAPS LOCK key on the keyboard while observing the CAPS LOCK LED. The LED should either turn ON or OFF after hitting the CAPS LOCK key. |
| Missing one of the primary colors (RED, GREEN, or BLUE) | Inspect the monitor's video cable and make sure that no pin is damaged. Make sure the monitor's video cable is properly connected to the computer. |
| Screen image is not centered or sized properly | Adjust H-Position and V-Position or press hot-key (AUTO). |
| Picture has color defects (white does not look white) | Adjust RGB color or select desired color temperature. |
| Horizontal or vertical disturbances on the screen | Use Windows 7/8/10 shut-down mode to adjust CLOCK and FOCUS. Press hot-key (AUTO) to auto-adjust. |
| Regulation & Service | Please refer to Regulation & Service Information which is in the CD manual or www.aoc.com (to find the model you purchase in your country and to find Regulation & Service Information in Support page. |

Specification

General Specification

| | | | |
|--|-------------------------------|--|----------------------------|
| Panel | Model name | AG405UXC | |
| | Driving system | TFT Color LCD | |
| | Viewable Image Size | 100.4 cm diagonal (39.5") | |
| | Pixel pitch | 0.26925mm(H) x 0.26925mm(V) | |
| | Video | HDMI /DP/USB C | |
| | Display Color | 16.7M Colors | |
| Others | Horizontal scan range | 30k-160kHz (HDMI) 30k-220kHz (DP/USB C) | |
| | Horizontal scan Size(Maximum) | 926.22mm | |
| | Vertical scan range | 48-120Hz (HDMI) 48-144Hz (DP/USB C) | |
| | Vertical Scan Size(Maximum) | 387.72mm | |
| | Optimal preset resolution | 3440x1440@60Hz | |
| | Max resolution | 3440x1440@100Hz (HDMI) 3440x1440@144Hz (DP/USB C*) | |
| | Plug & Play | VESA DDC2B/CI | |
| | Connector | HDMIx2, DP,USB C(DP Alt), USBx4, USB Up, Earphone, Quick switch port | |
| | Power Source | 100-240V~, 50/60Hz, 3A | |
| | Power Consumption | Typical(default brightness and contrast) | 45 W |
| Max. (brightness = 100, contrast =100) | | ≤225W | |
| Standby mode | | ≤ 0.5 W | |
| USB C | USB C | Reversible plug connector | |
| | Super speed | Data and Video transfer | |
| | DP | Built-in DisplayPort Alt mode | |
| | Power Delivery | USB PD version 3.0 | |
| | Max power delivery | Up to 90W (5V/3A, 9V/3A, 10V/3A, 12V/3A, 15V/3A, 20V/4.5A) | |
| Environmental | Temperature | Operating | 0°C~ 40°C |
| | | Non-Operating | -25°C~ 55°C |
| | Humidity | Operating | 10% ~ 85% (non-condensing) |
| | | Non-Operating | 5% ~ 93% (non-condensing) |
| | Altitude | Operating | 0~ 5000 m (0~ 16404ft) |
| | | Non-Operating | 0~ 12192m (0~ 40000ft) |

*:When the USB C(DP Alt) is set to USB2.0 or off, the max resolution of USB C interface is 3440x1440@144Hz.

Preset Display Modes

| STANDARD | RESOLUTION | HORIZONTAL FREQUENCY(kHz) | VERTICAL FREQUENCY(Hz) |
|----------|------------------------|---------------------------|------------------------|
| VGA | 640x480@60Hz | 31.469 | 59.94 |
| | 640x480@72Hz | 37.861 | 72.809 |
| | 640x480@75Hz | 37.5 | 75 |
| | 640 x 480@100Hz | 50.313 | 99.826 |
| SVGA | 800x600@60Hz | 37.879 | 60.317 |
| | 800x600@72Hz | 48.077 | 72.188 |
| | 800x600@75Hz | 46.875 | 75 |
| | 800x600@100Hz | 62.76 | 99.778 |
| XGA | 1024x768@60Hz | 48.363 | 60.004 |
| | 1024x768@70Hz | 56.476 | 70.069 |
| | 1024x768@75Hz | 60.023 | 75.029 |
| | 1024 x 768@100Hz | 80.448 | 99.811 |
| SXGA | 1280x1024@60Hz | 63.981 | 60.020 |
| | 1280x1024@75Hz | 79.976 | 75.025 |
| WXGA+ | 1440x900@60Hz | 55.935 | 59.887 |
| | 1440x900@60Hz | 55.469 | 59.901 |
| WSXGA | 1680x1050@60Hz | 65.290 | 59.954 |
| | 1680x1050@60Hz | 64.674 | 59.883 |
| FHD | 1920x1080@60Hz | 67.5 | 60 |
| WQHD | 3440x1440@30Hz | 44.408 | 29.985 |
| | 3440x1440@60Hz | 89.819 | 59.973 |
| | 3440x1440@75Hz | 111.875 | 74.983 |
| | 3440x1440@100Hz | 150.972 | 99.982 |
| | 3440X1440@120Hz(USB C) | 181.2 | 120 |
| | 3440X1440@144Hz(USB C) | 214.56 | 144 |
| IBM | | | |
| DOS | 640x350@70Hz | 31.469 | 70.087 |
| | 720x400@70Hz | 31.469 | 70.087 |
| MAC | | | |
| VGA | 640x480@67Hz | 35.000 | 66.667 |
| SVGA | 832x624@75Hz | 49.725 | 74.551 |
| XGA | 1024x768@75Hz | 60.241 | 74.927 |

Pin Assignments

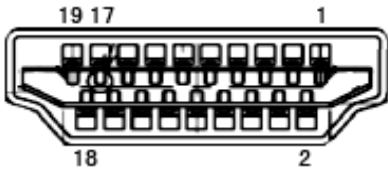

19-Pin Color Display Signal Cable

| Pin No. | Signal Name | Pin No. | Signal Name | Pin No. | Signal Name |
|---------|--------------------|---------|---------------------------|---------|-----------------|
| 1. | TMDS Data 2+ | 9. | TMDS Data 0- | 17. | DDC/CEC Ground |
| 2. | TMDS Data 2 Shield | 10. | TMDS Clock + | 18. | +5V Power |
| 3. | TMDS Data 2- | 11. | TMDS Clock Shield | 19. | Hot Plug Detect |
| 4. | TMDS Data 1+ | 12. | TMDS Clock- | | |
| 5. | TMDS Data 1Shield | 13. | CEC | | |
| 6. | TMDS Data 1- | 14. | Reserved (N.C. on device) | | |
| 7. | TMDS Data 0+ | 15. | SCL | | |
| 8. | TMDS Data 0 Shield | 16. | SDA | | |

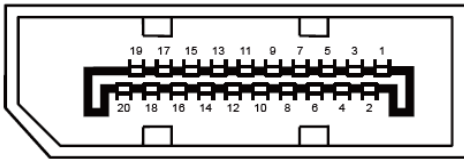

20-Pin Color Display Signal Cable

| Pin No. | Signal Name | Pin No. | Signal Name |
|---------|---------------|---------|-----------------|
| 1 | ML_Lane 3 (n) | 11 | GND |
| 2 | GND | 12 | ML_Lane 0 (p) |
| 3 | ML_Lane 3 (p) | 13 | CONFIG1 |
| 4 | ML_Lane 2 (n) | 14 | CONFIG2 |
| 5 | GND | 15 | AUX_CH(p) |
| 6 | ML_Lane 2 (p) | 16 | GND |
| 7 | ML_Lane 1 (n) | 17 | AUX_CH(n) |
| 8 | GND | 18 | Hot Plug Detect |
| 9 | ML_Lane 1 (p) | 19 | Return DP_PWR |
| 10 | ML_Lane 0 (n) | 20 | DP_PWR |

Plug and Play

Plug & Play DDC2B Feature

This monitor is equipped with VESA DDC2B capabilities according to the VESA DDC STANDARD. It allows the monitor to inform the host system of its identity and, depending on the level of DDC used, communicate additional information about its display capabilities.

The DDC2B is a bi-directional data channel based on the I2C protocol. The host can request EDID information over the DDC2B channel.